

2-320568-3 ✓ ACTIVE



PIDG

TE Internal #: 2-320568-3

Ring Terminals & Spade Terminals, Ring Tongue, 10 AWG Wire Size, 6.11 mm<sup>2</sup> Wire Size, 12066 CMA Wire Size, Stud Size M4, PIDG

[View on TE.com >](#)

Terminals & Splices > Ring Terminals & Spade Terminals > PIDG RING TONGUE TERMINALS

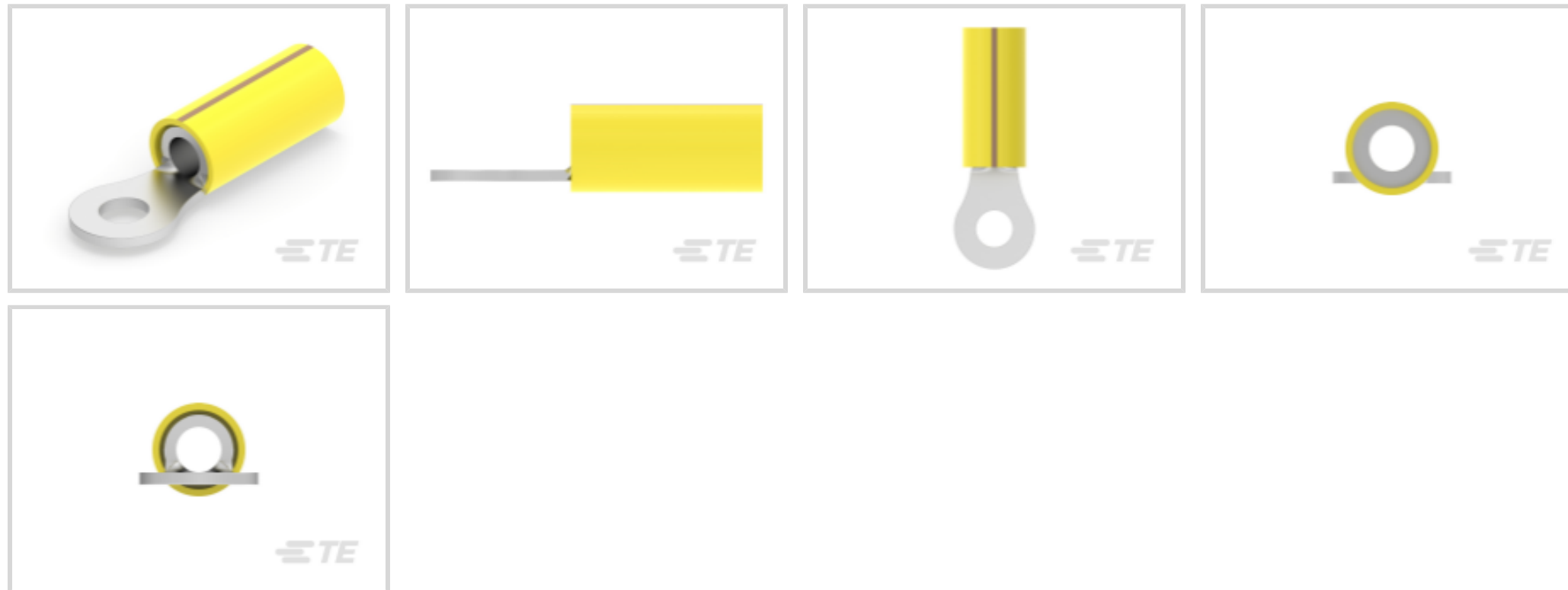

Ring & Spade Terminal Type: **Ring Tongue**

Wire Size: **12066 CMA**

Stud Size: **M4**

[All PIDG RING TONGUE TERMINALS \(421\)](#)

### Features

#### Product Type Features

Shape Description	RING-042
Stud Size	M4
Sealable	No
Wire Insulation Support Retention Type	Insulation Restriction

#### Configuration Features

Number of Holes	1
Terminal Angle	180 °

#### Electrical Characteristics

Voltage (Max)	300 V
---------------	-------

#### Body Features

Weight per Piece	1.919 g
Stripe Color	Brown

#### Contact Features

Military Part Class	Class I
---------------------	---------



Ring & Spade Terminal Type	Ring Tongue
----------------------------	-------------

Barrel Type	Closed
-------------	--------

Terminal Orientation	Offset
----------------------	--------

Terminal Plating Material	Tin
---------------------------	-----

### Mechanical Attachment

Wire Insulation Support	With
-------------------------	------

### Dimensions

Wire Size	12066 CMA
-----------	-----------

Stud Diameter	4.17 mm[.164 in]
---------------	------------------

Tongue Thickness	.79 mm[.031 in]
------------------	-----------------

Overall Product Length	29.16 mm[1.148 in]
------------------------	--------------------

Accepts Wire Insulation Diameter (Max)	5.08 mm[.2 in]
--	----------------

Accepts Wire Insulation Diameter Range	3.02 – 5.08 mm[.119 – .2 in]
--	------------------------------

### Usage Conditions

Insulation Option	Partially Insulated
-------------------	---------------------

Operating Temperature Range	105 °C[221 °F]
-----------------------------	----------------

### Operation/Application

Compatible With Wire Base Material	Copper
------------------------------------	--------

Compatible With Wire Plating Material	Tin
---------------------------------------	-----

Heavy Duty	No
------------	----

### Industry Standards

Government Qualified	Yes
----------------------	-----

### Packaging Features

Packaging Quantity	500
--------------------	-----

Packaging Method	Loose Piece
------------------	-------------

### Product Compliance

[For compliance documentation, visit the product page on TE.com>](#)

EU RoHS Directive 2011/65/EU	Compliant
------------------------------	-----------

EU ELV Directive 2000/53/EC	Compliant
-----------------------------	-----------

China RoHS 2 Directive MIIT Order No 32, 2016	No Restricted Materials Above Threshold
---	---

EU REACH Regulation (EC) No. 1907/2006	
--	--



Current ECHA Candidate List: JUNE 2022  
(224)

Candidate List Declared Against: JAN 2022  
(223)

Does not contain REACH SVHC

Halogen Content

Not Low Halogen - contains Br or Cl > 900 ppm.

Solder Process Capability

Not applicable for solder process capability

Product Compliance Disclaimer

This information is provided based on reasonable inquiry of our suppliers and represents our current actual knowledge based on the information they provided. This information is subject to change. The part numbers that TE has identified as EU RoHS compliant have a maximum concentration of 0.1% by weight in homogenous materials for lead, hexavalent chromium, mercury, PBB, PBDE, DBP, BBP, DEHP, DIBP, and 0.01% for cadmium, or qualify for an exemption to these limits as defined in the Annexes of Directive 2011/65/EU (RoHS2). Finished electrical and electronic equipment products will be CE marked as required by Directive 2011/65/EU. Components may not be CE marked. Additionally, the part numbers that TE has identified as EU ELV compliant have a maximum concentration of 0.1% by weight in homogenous materials for lead, hexavalent chromium, and mercury, and 0.01% for cadmium, or qualify for an exemption to these limits as defined in the Annexes of Directive 2000/53/EC (ELV). Regarding the REACH Regulation, the information TE provides on SVHC in articles for this part number is based on the latest European Chemicals Agency (ECHA) 'Guidance on requirements for substances in articles' posted at this URL: <https://echa.europa.eu/guidance-documents/guidance-on-reach>

## Compatible Parts



TE Part # 59824-1  
TETRA-CRIMP PIDG PG FASTON 22-10 ASSY



TE Part # 58433-3  
PRO CR ASSY, RBY IS9252



TE Part # 59239-4  
HHHT PIDG PG 12-10 ASSY



TE Part # 58423-1  
DIE, RBY IS9252



TE Part # 2063030-1  
SDE DIESET, RBY, UL



TE Part # 47808-6  
DIES PIDG 12-10 DIE SET

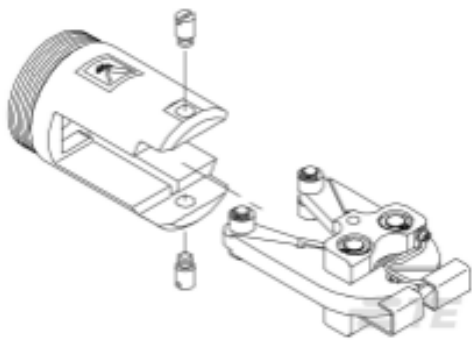

TE Part # 679300-1  
1210 PIDG CRIMP HEAD



TE Part # 1-59239-4  
HHHT PIDG 16-10 HEAD



## Also in the Series | PIDG

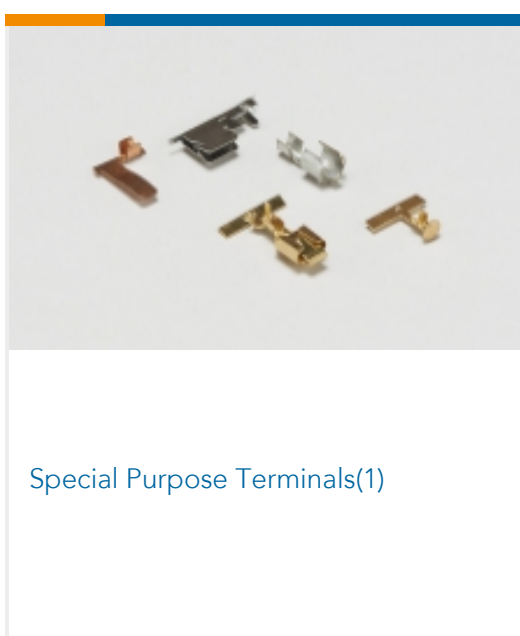
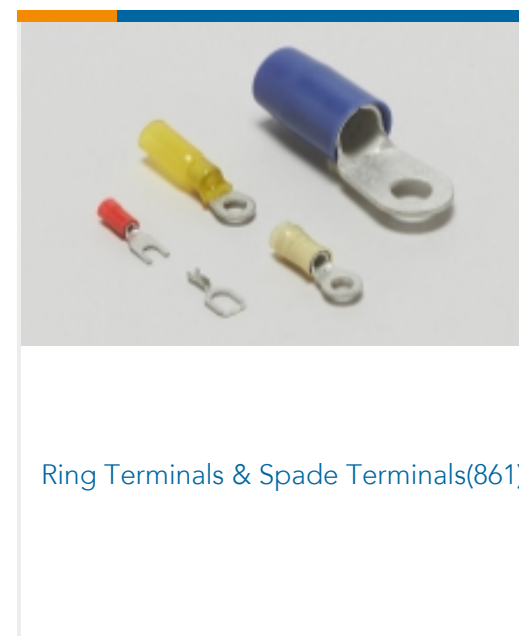
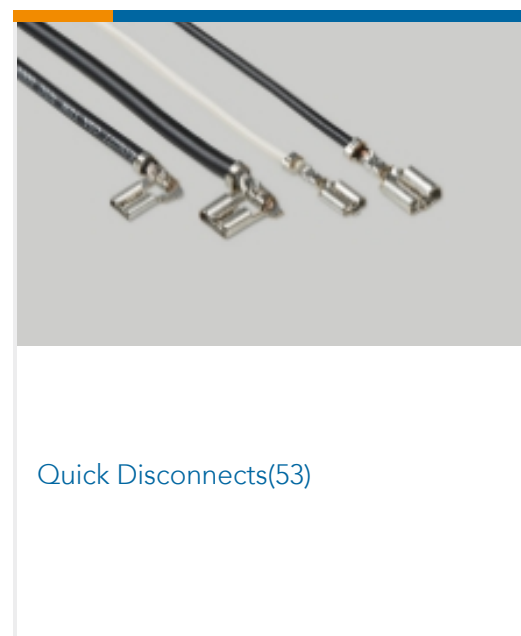
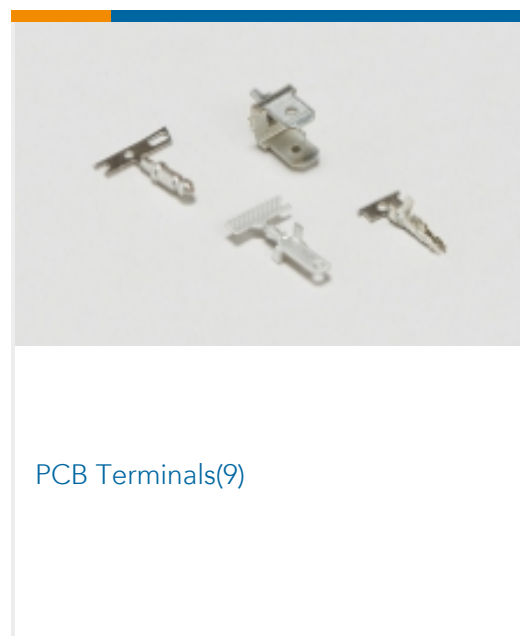
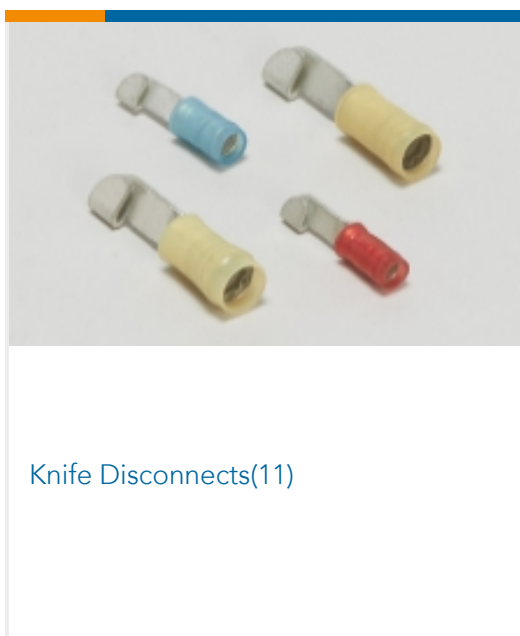
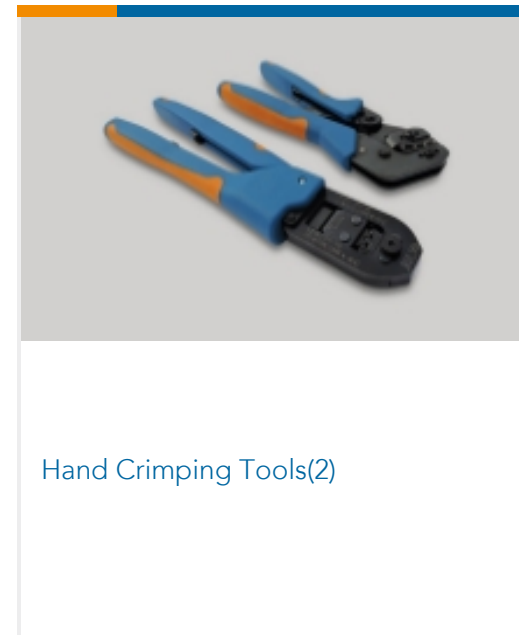
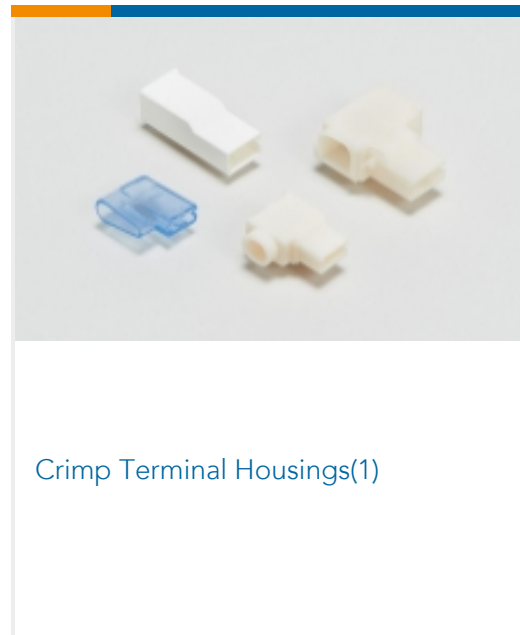
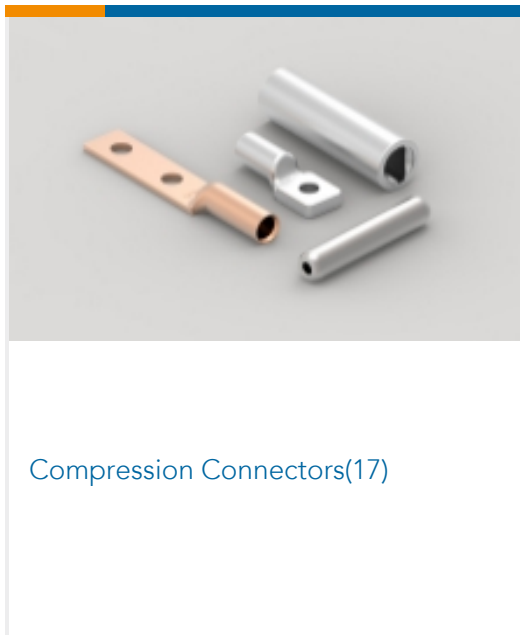

## Documents

[Product Drawings](#)  
[TERMINAL,PIDG R IR 10 8](#)

English

[CAD Files](#)  
[3D PDF](#)  
[3D](#)  
[Customer View Model](#)



[ENG\\_CVM\\_CVM\\_2-320568-3\\_AC.2d\\_dxf.zip](#)

English

**Customer View Model**

[ENG\\_CVM\\_CVM\\_2-320568-3\\_AC.3d\\_igs.zip](#)

English

**Customer View Model**

[ENG\\_CVM\\_CVM\\_2-320568-3\\_AC.3d\\_stp.zip](#)

English

By downloading the CAD file I accept and agree to the [Terms and Conditions](#) of use.

---

### Product Specifications

[Application Specification](#)

English

---

### Product Environmental Compliance

[TE Material Declaration](#)

English

---

### Agency Approvals

[CSA Certificate](#)

English